

How to make a board game

Follow the instructions below to see how you can make your board game! Remember change the dimensions depending on your game.

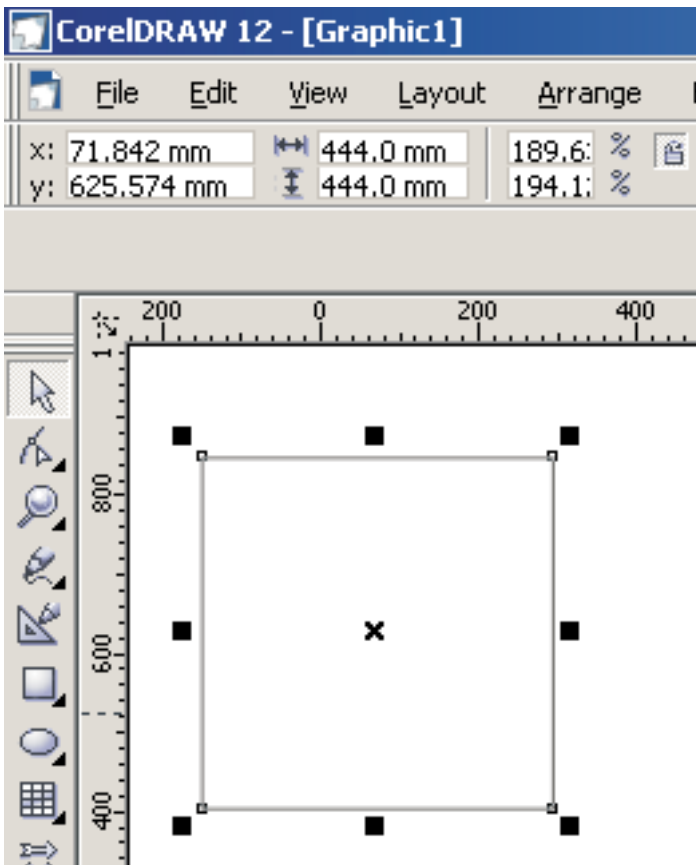

1) Draw your board and enter your dimensions into the dimensions box. Here I have created a board at 444mm x 444mm.

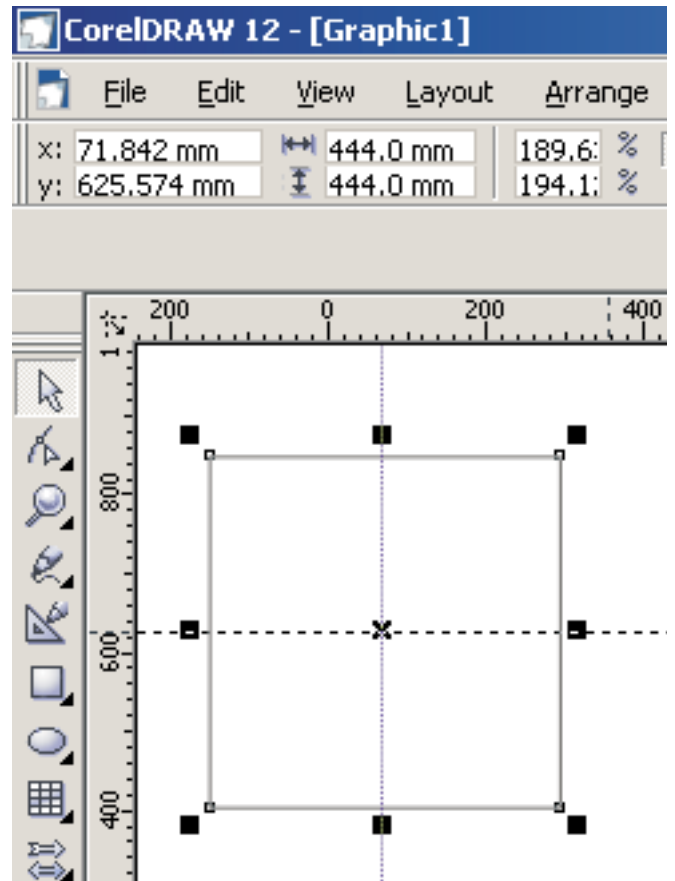

2) Now select the shape with the arrow tool. Next drag a guideline from the ruler onto the shape. Drag it to the centre of the shape. You will need to do this twice horizontally and vertically.

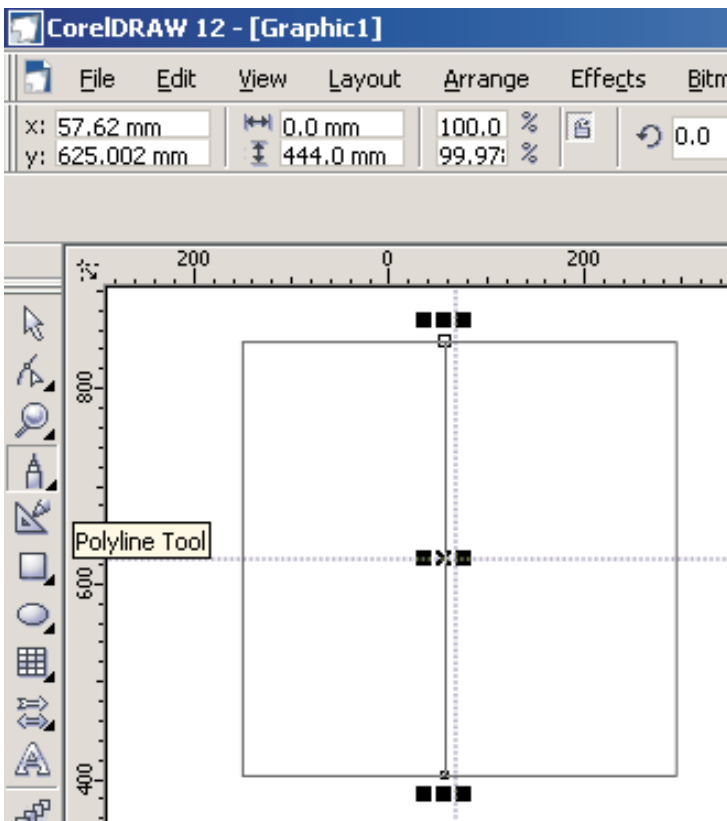

3) Next draw a straight line using the polyline tool. Then click within the dimensions box and make it the same size as your board here I have made it 444mm.

How to make a board game

2

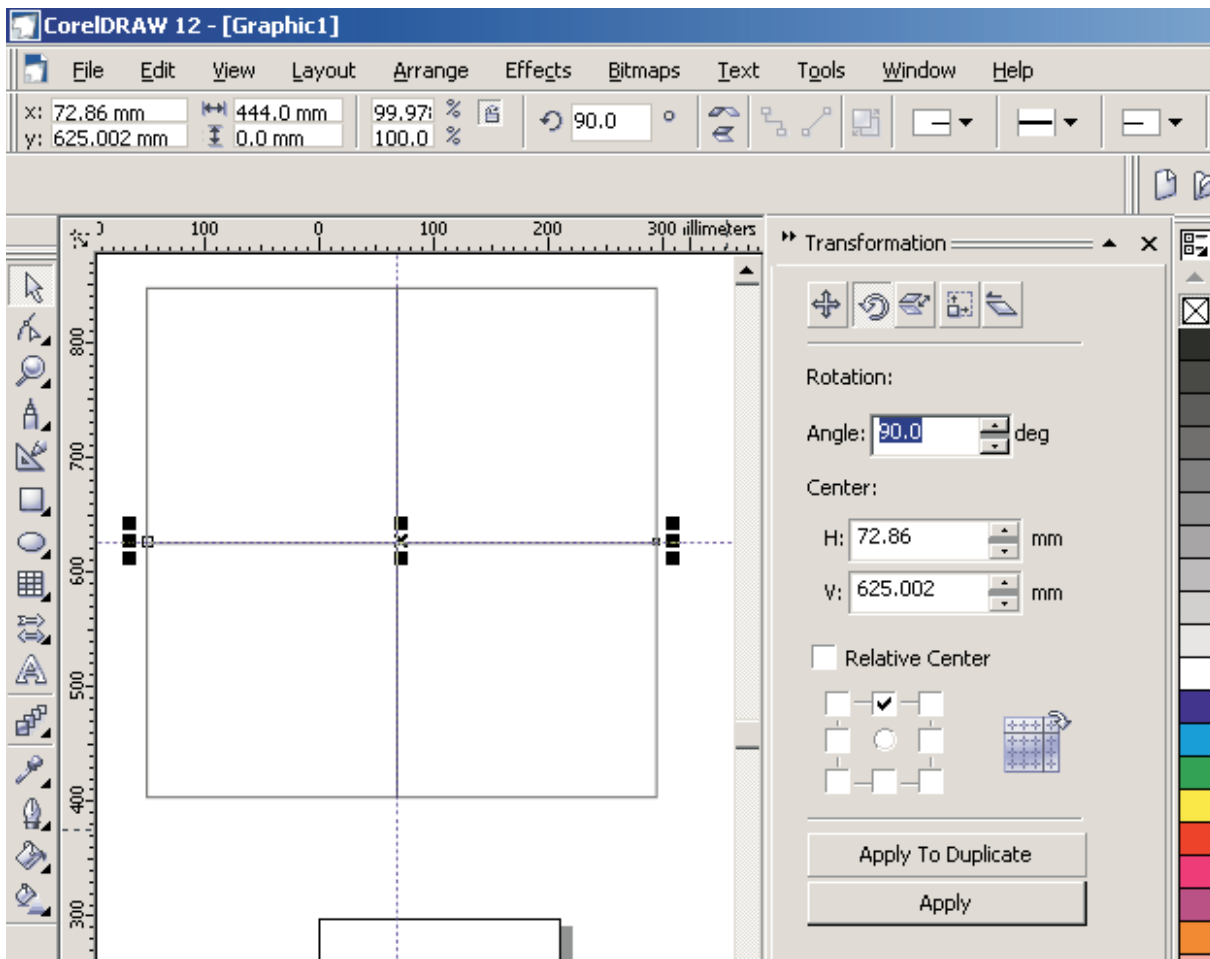

4) Next copy and paste the line. Press the 'ctl' button down and 'c' then press the 'ctl' button down and press 'v'. Next click on the rotate transformation dock and enter 90 degree's then press apply.

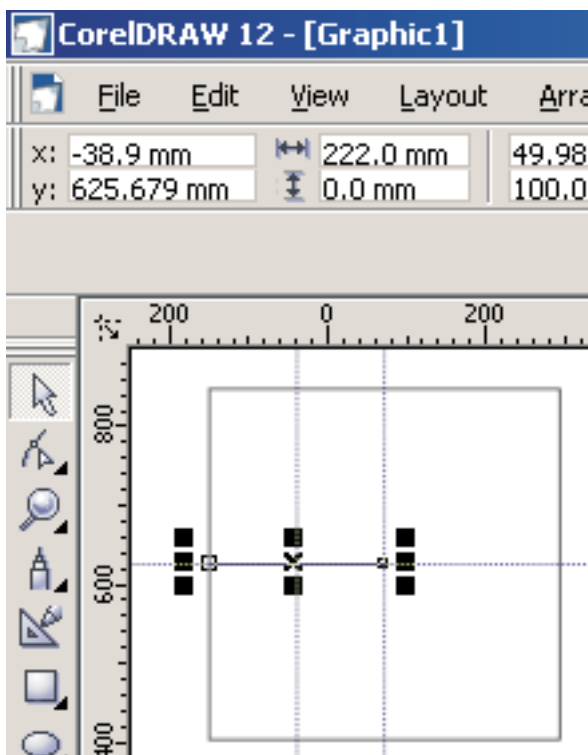

5) Next I made my line 222 half the size of the board and added a guideline to the centre. I need to do this so later I can add a jigsaw section to my board.

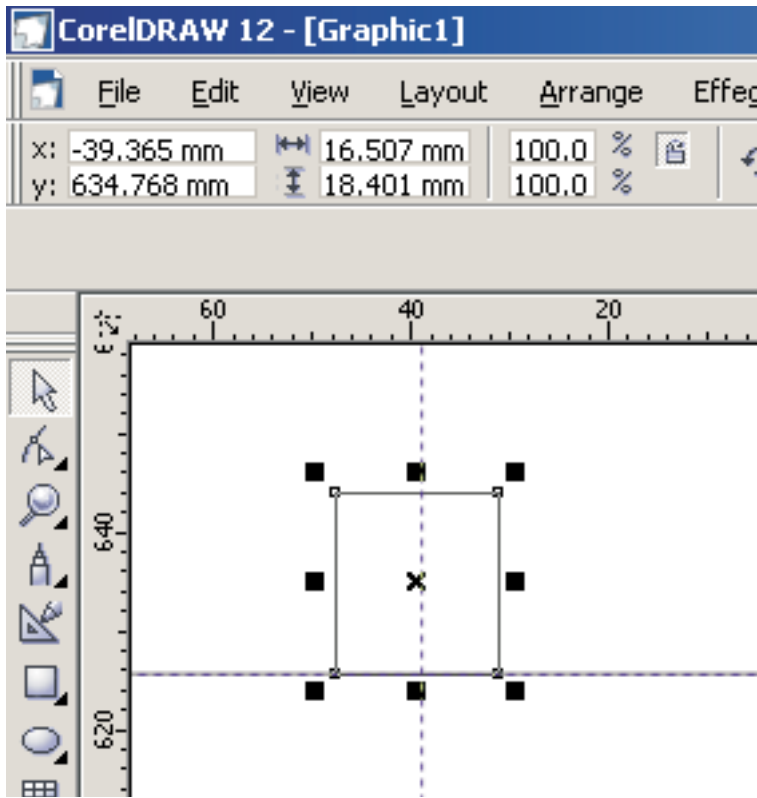

6) Now add a shape and centre it on your guideline.

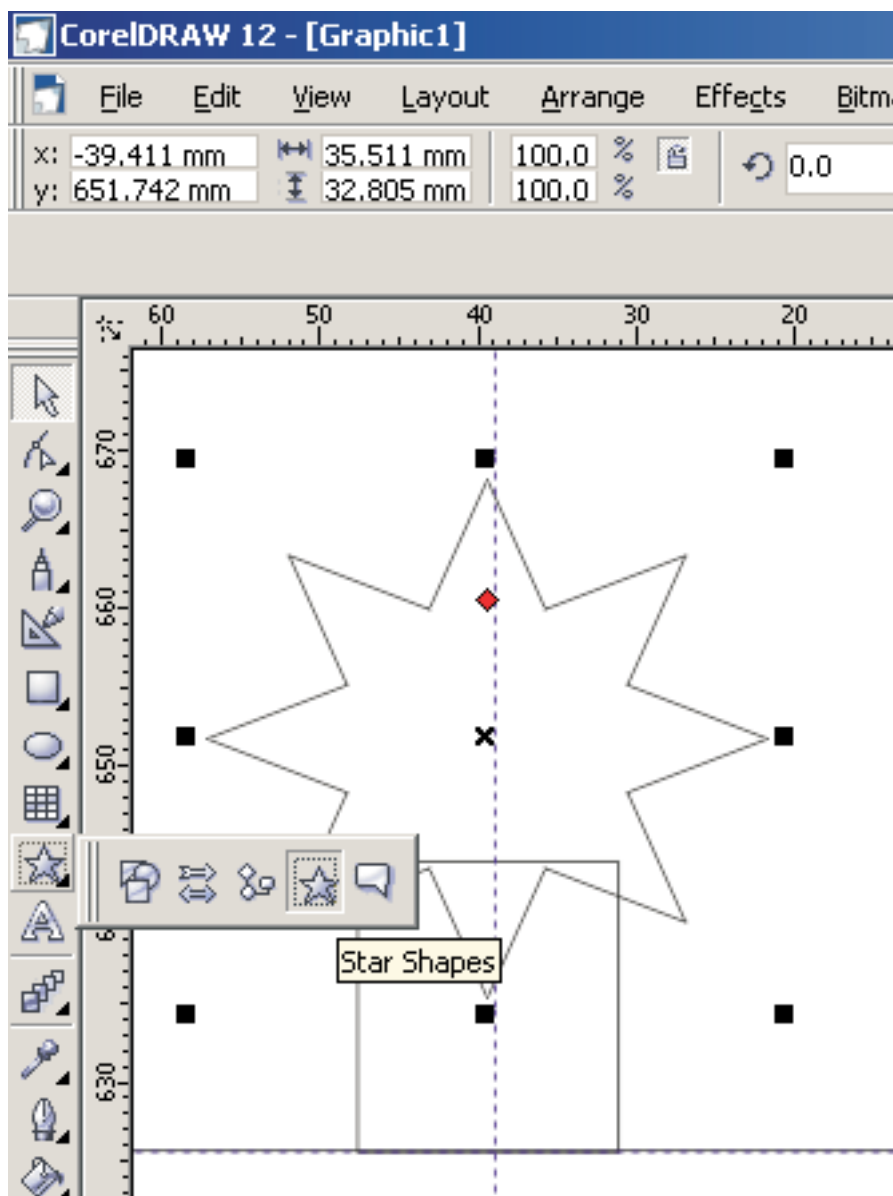

7) Now add a shape to the top of your rectangle. I have added a star shape. You can add whatever shape you wish. Now overlap the shape with the centre of your rectangle!

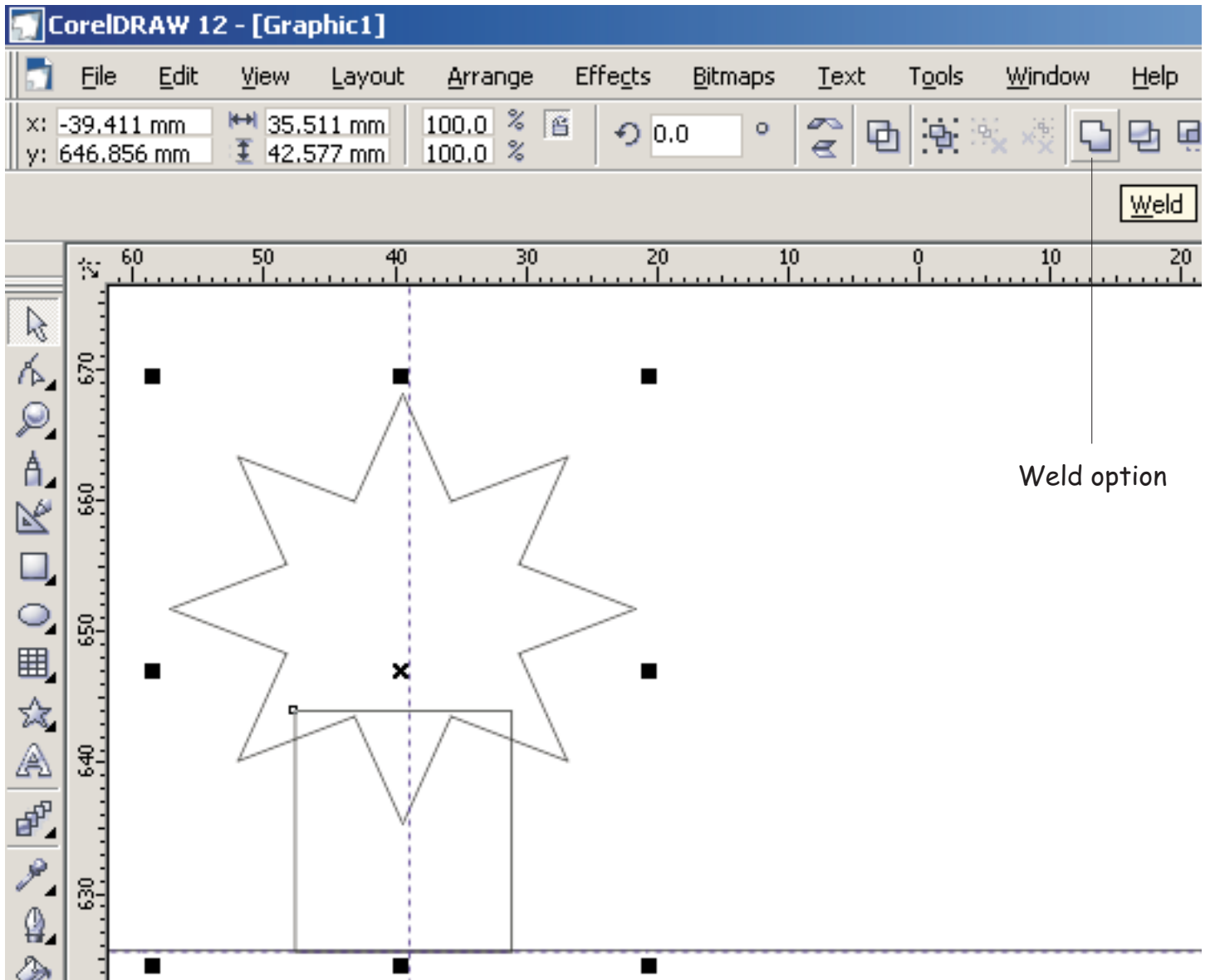

8) Now select both shapes using the arrow and the 'ctl' button. Once both shapes are selected click on the weld shape. This will now create a new shape!

How to make a board game

5

9) Now select the 'shape tool' and on the bottom of your shape right click on the 'node' and select the 'break apart' option.

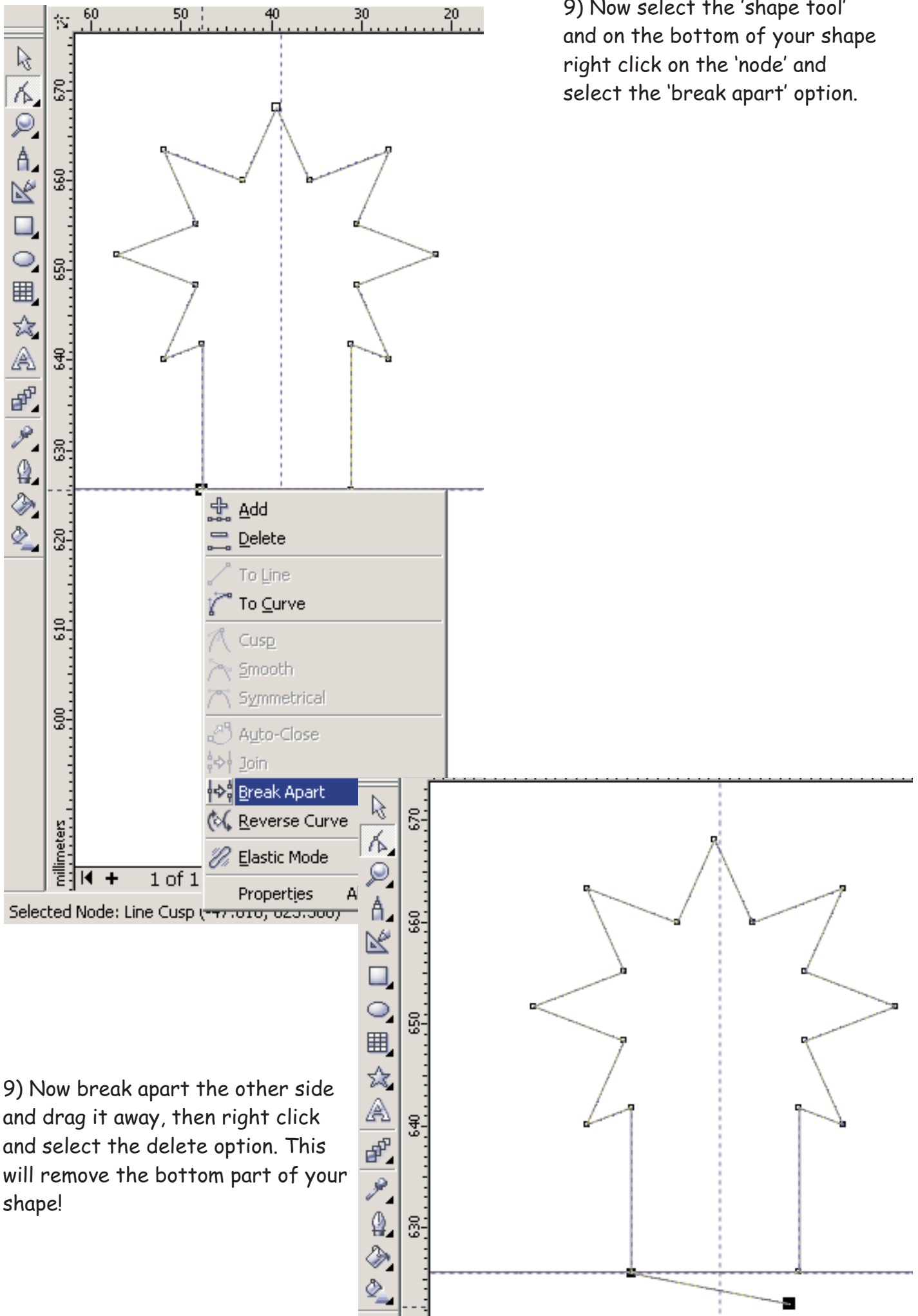

9) Now break apart the other side and drag it away, then right click and select the delete option. This will remove the bottom part of your shape!

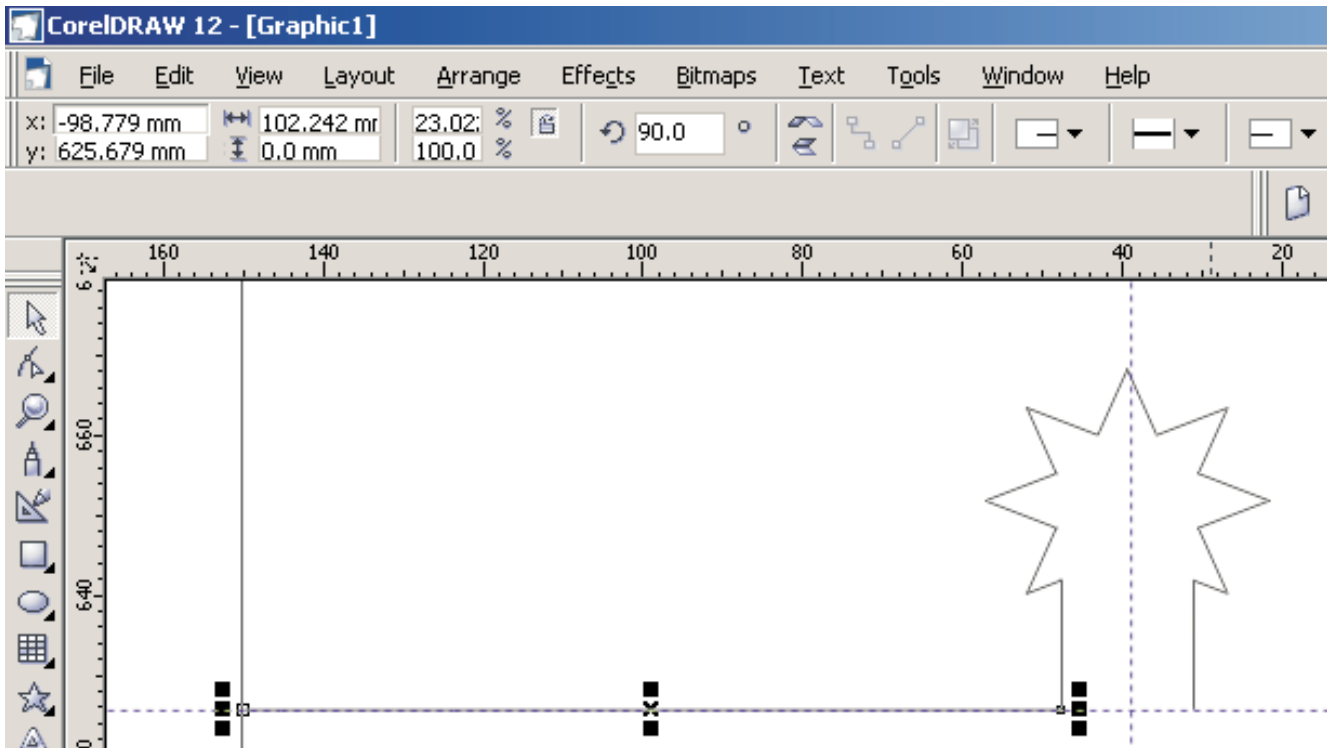

10) Now drag your line so it joins the bottom of your shape. Zoom in here as close as you can and ensure it lines up properly!

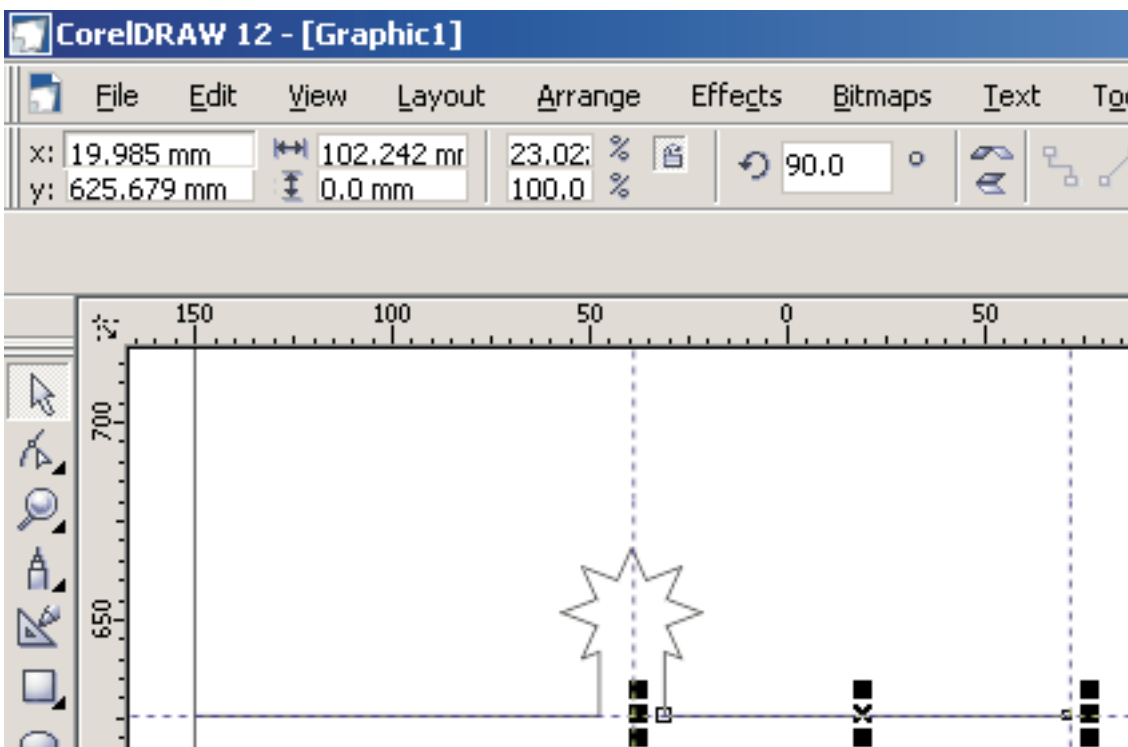

11) Now copy your line and move it across to the other side. The line should fit exactly into the centre of your board game as your jigsaw section is in the centred. Next draw a rectangle around both the lines and the jigsaw section and right click and select group. .

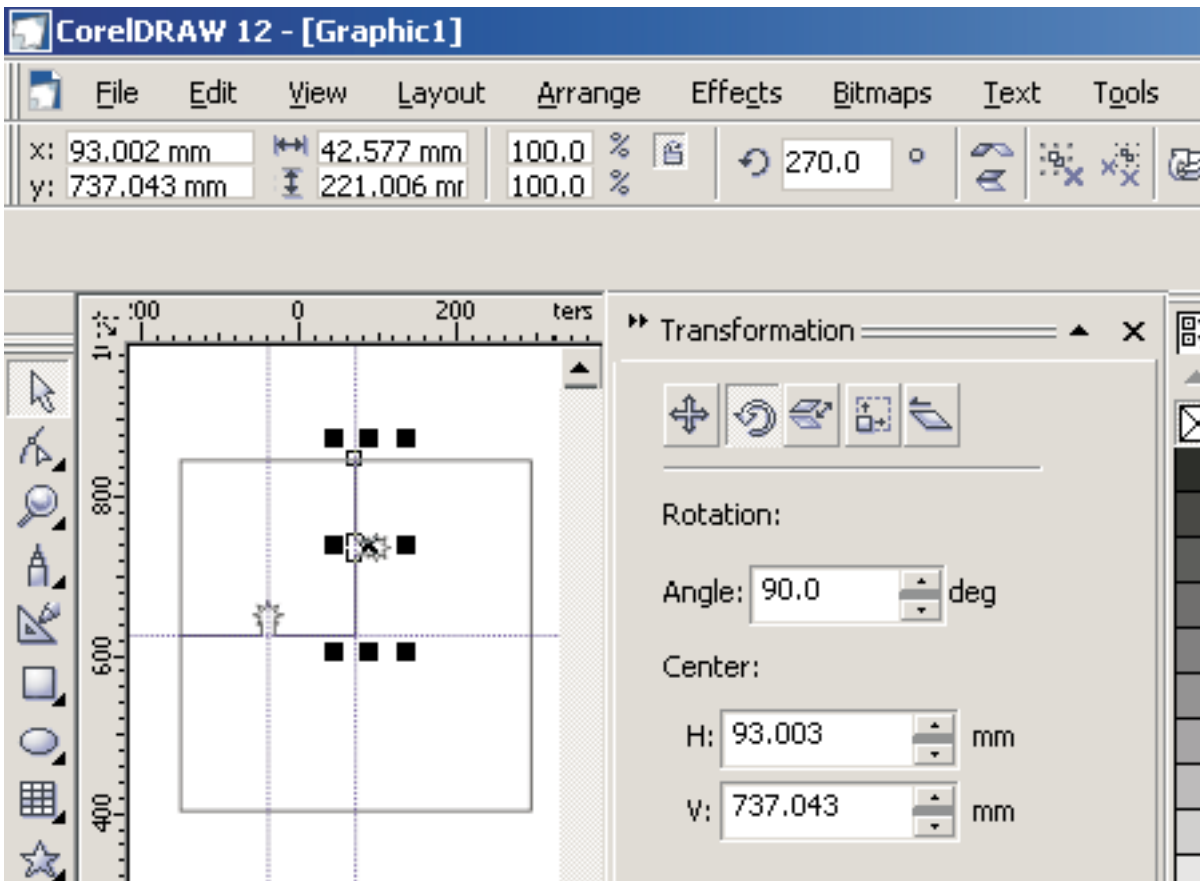

12) Now copy and paste your jigsaw section, then rotate the section by 90 degrees and move the section to the centre.

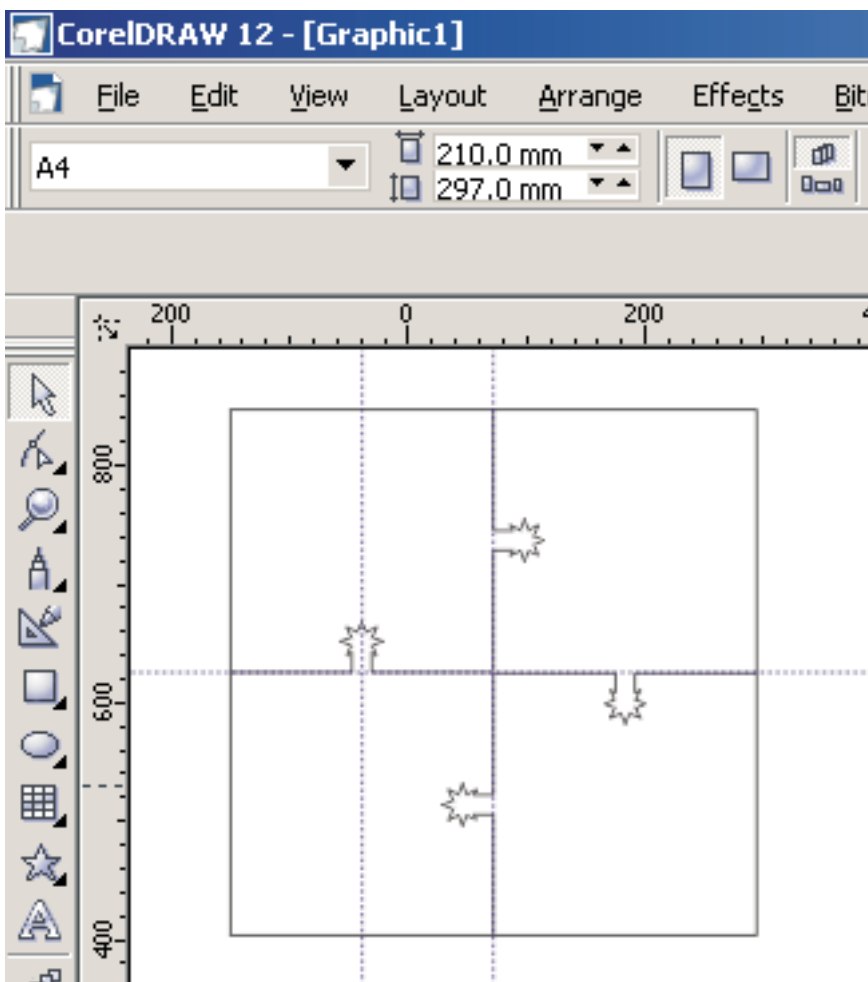

13) Now repeat the copy and paste and rotate process to complete your board.

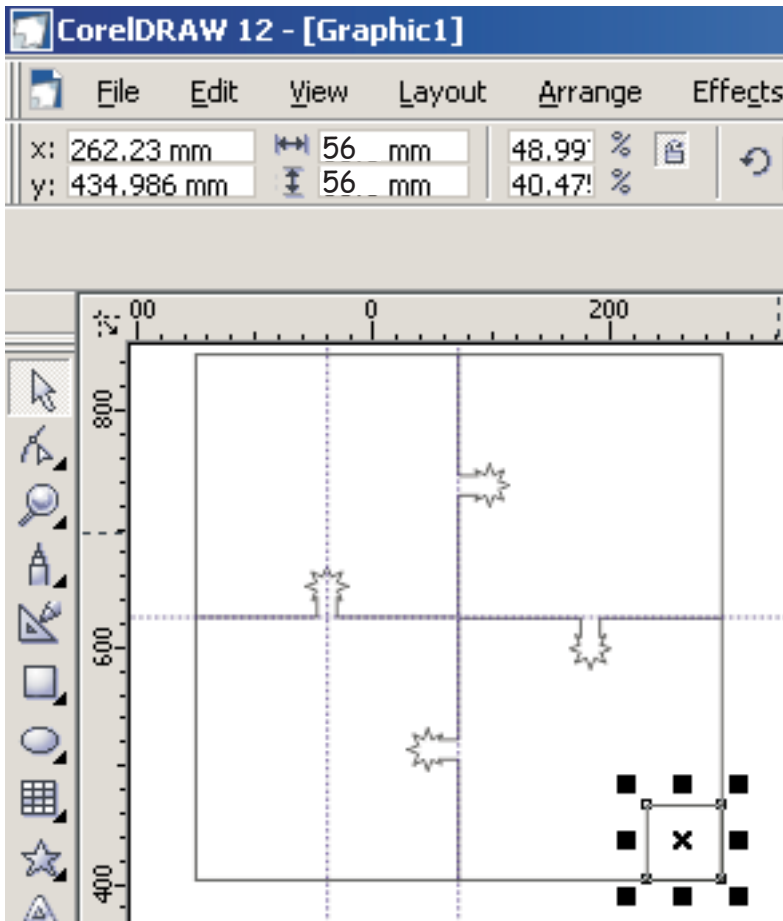

14) Now create a square at 56mm x 56mm and move it into the corner of your board. Make sure you zoom in to ensure it is right in the corner.

Note: You can also use the align options!
(Ask your teacher)

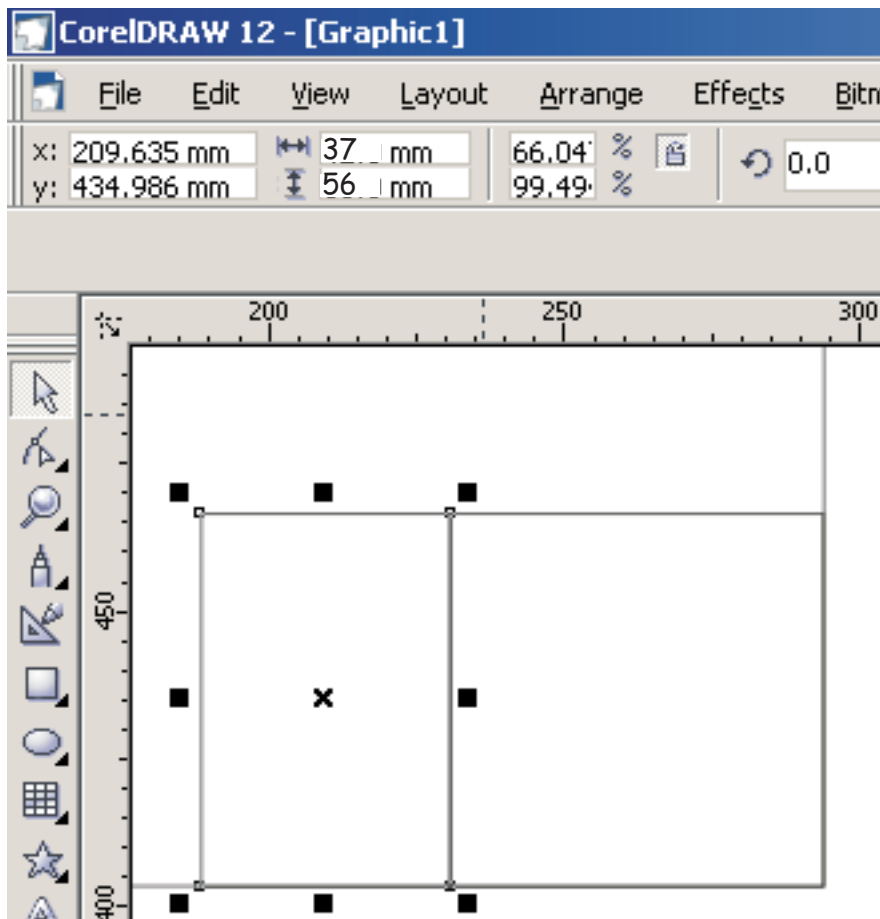

15) Next create a rectangle at 56mm x 37mm. Now zoom in and move it as close to the other shape as you can.

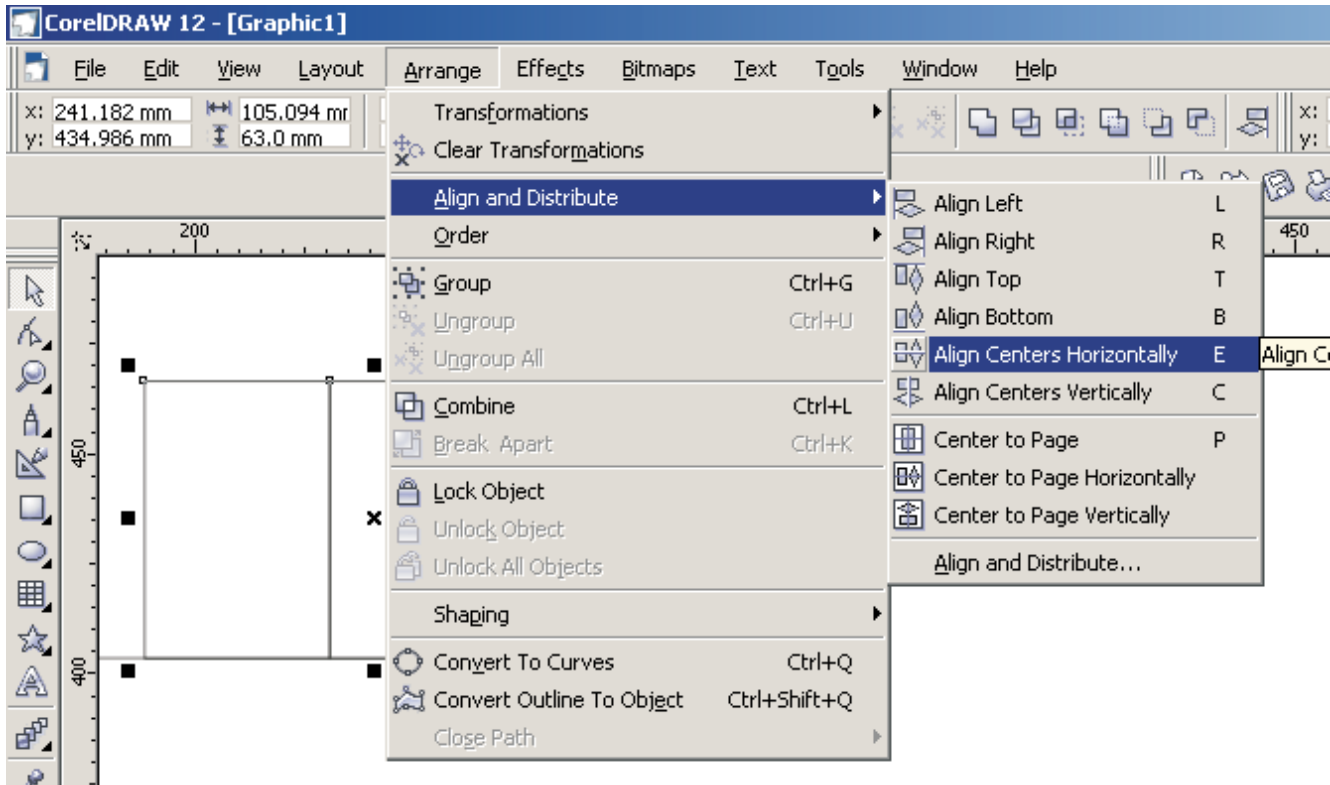

16) Now select both shapes and select arrange > align and distribute > and choose Align centres horizontally. This will align your shapes.

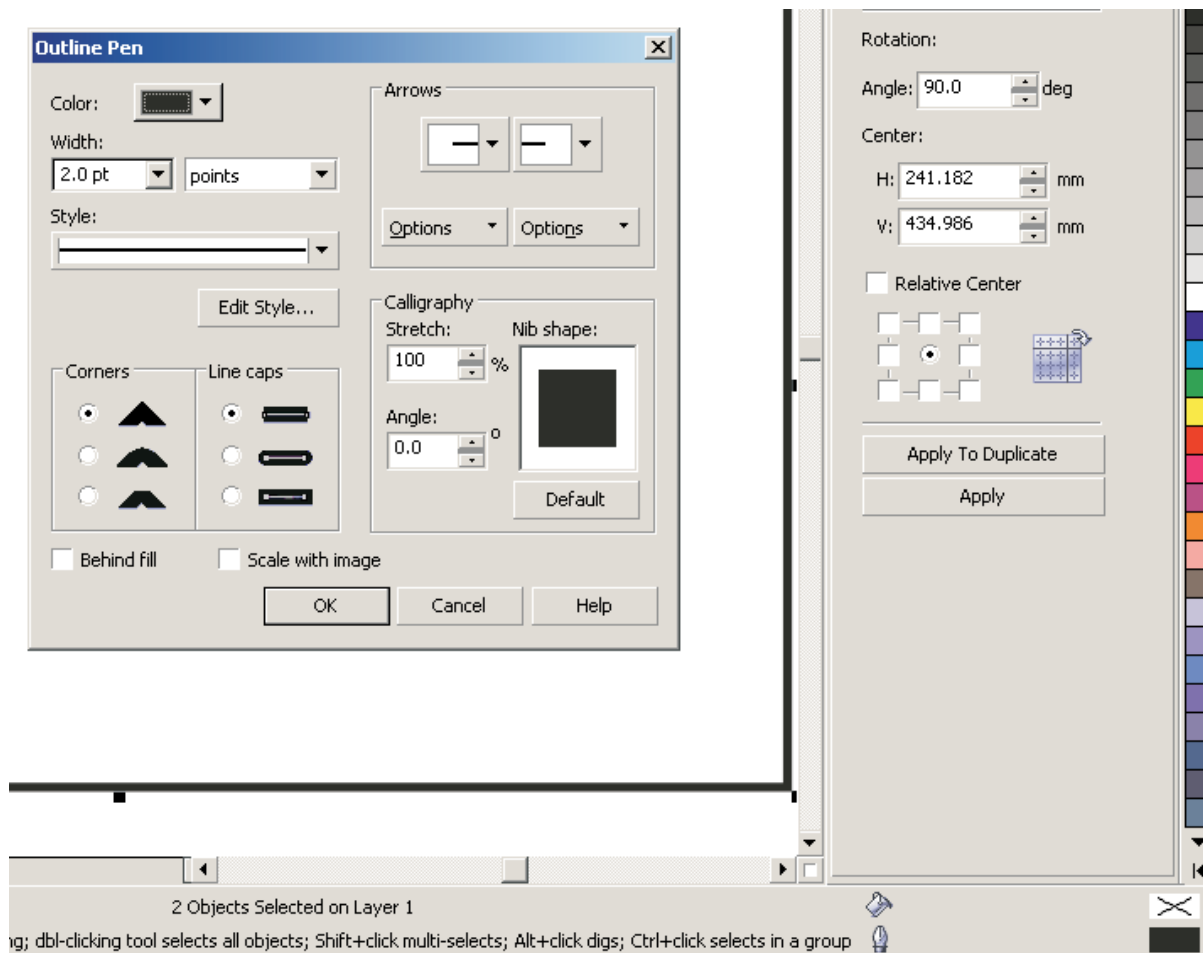

17) Now select both shapes and double click on the small rectangle in the corner of your screen. This will bring up the pen options, Next select a line width of 2.0pts and press OK.

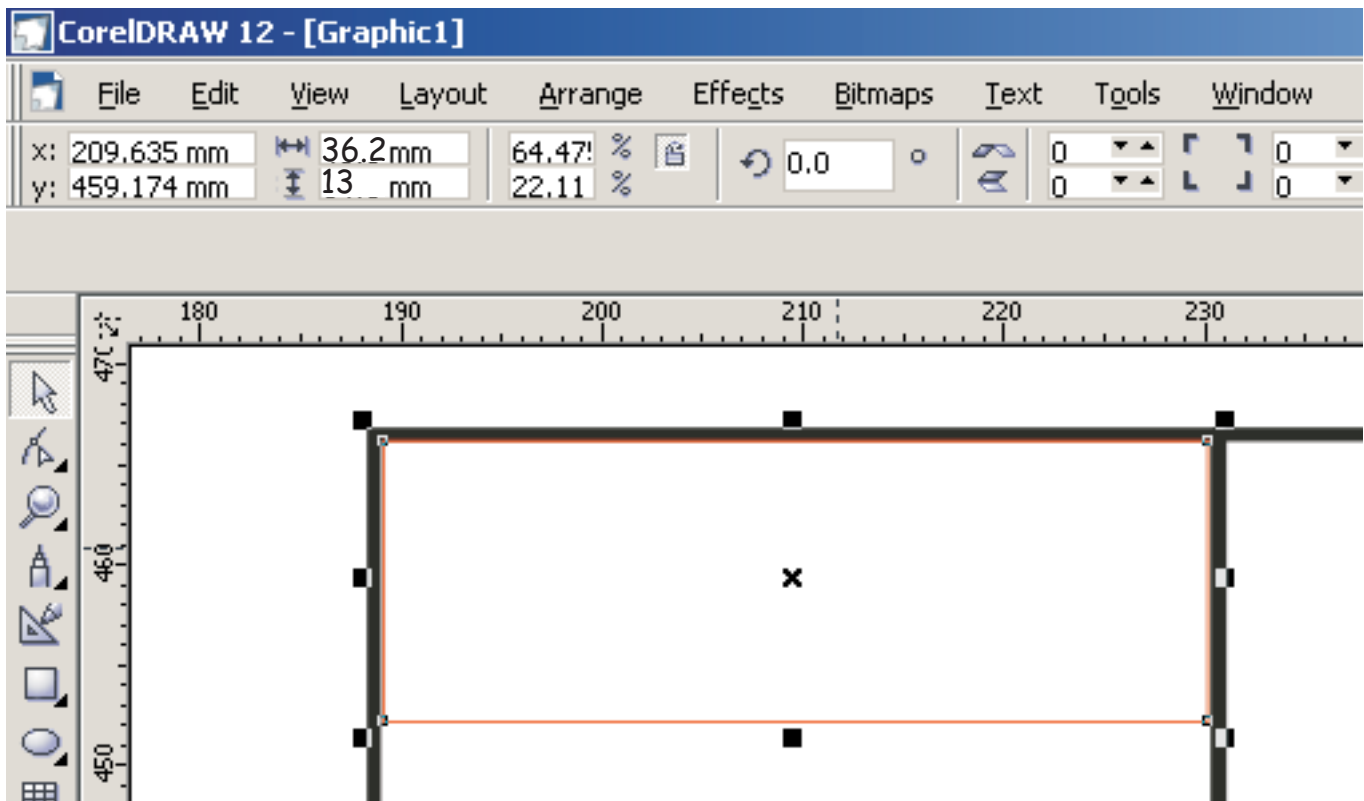

18) Now create a new rectangle that is 36.2mm x 13mm. Now double click on the small pen option and make the line red and make it a hair line. Now move it so it fits exactly inside the top of your black rectangle. (See above!)

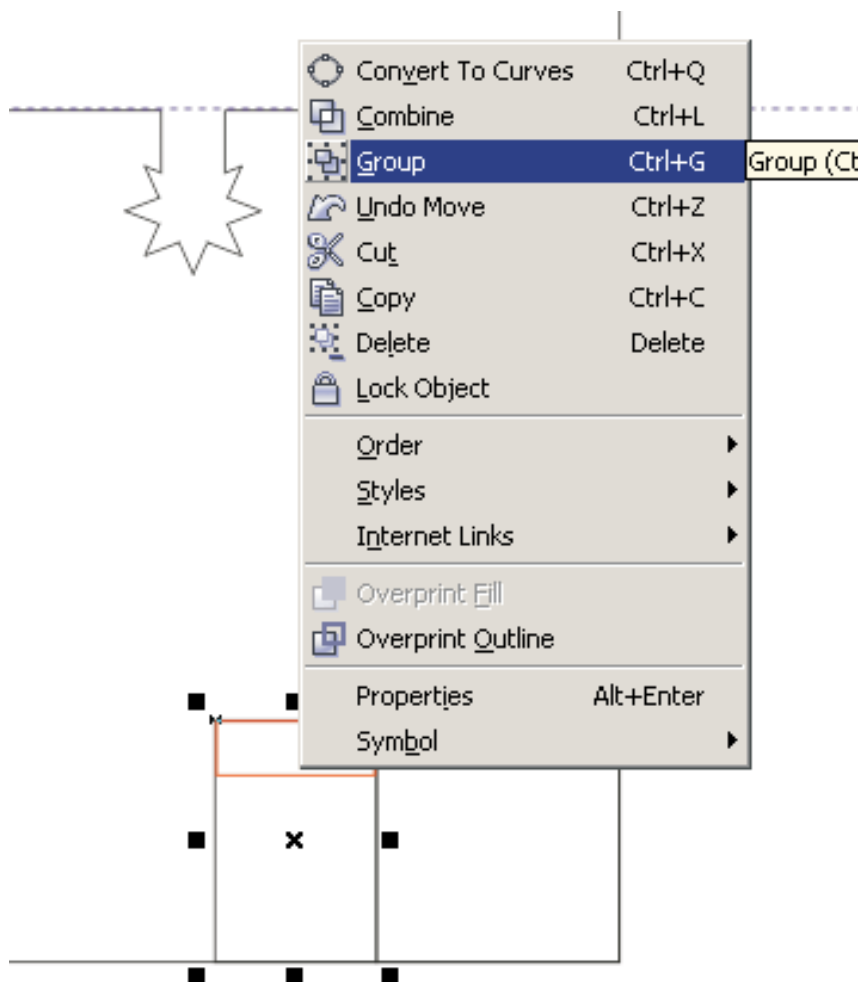

19) Now create a rectangle around the black rectangle and red rectangle and press group.

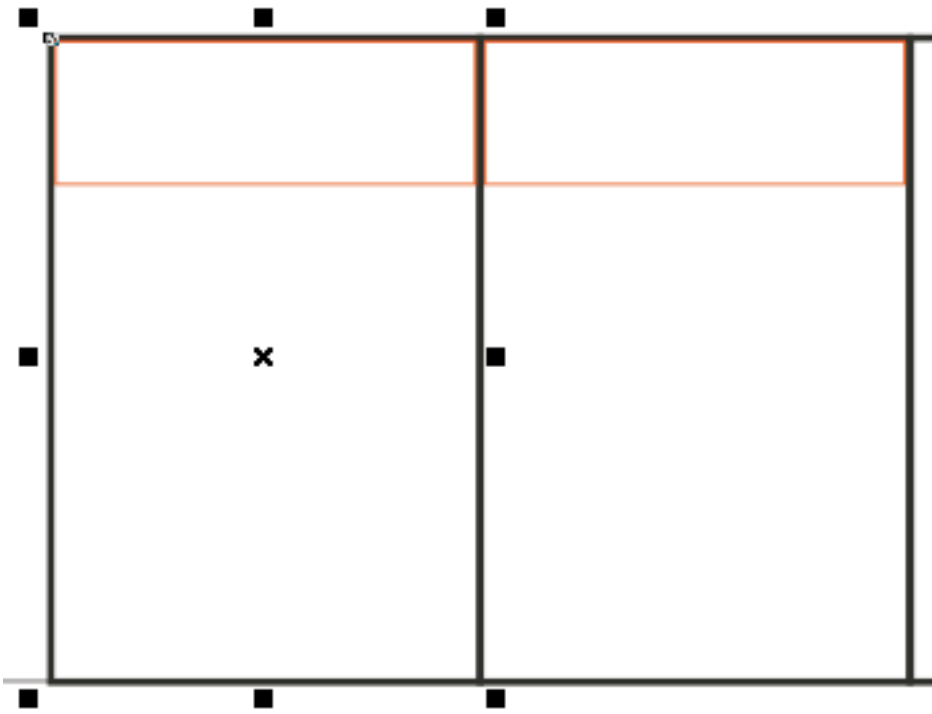

20) Now copy and paste the selection and move it next to your first rectangle. Now keep on doing this until you have added nine rectangles. Make sure you zoom in to ensure they are aligned properly.

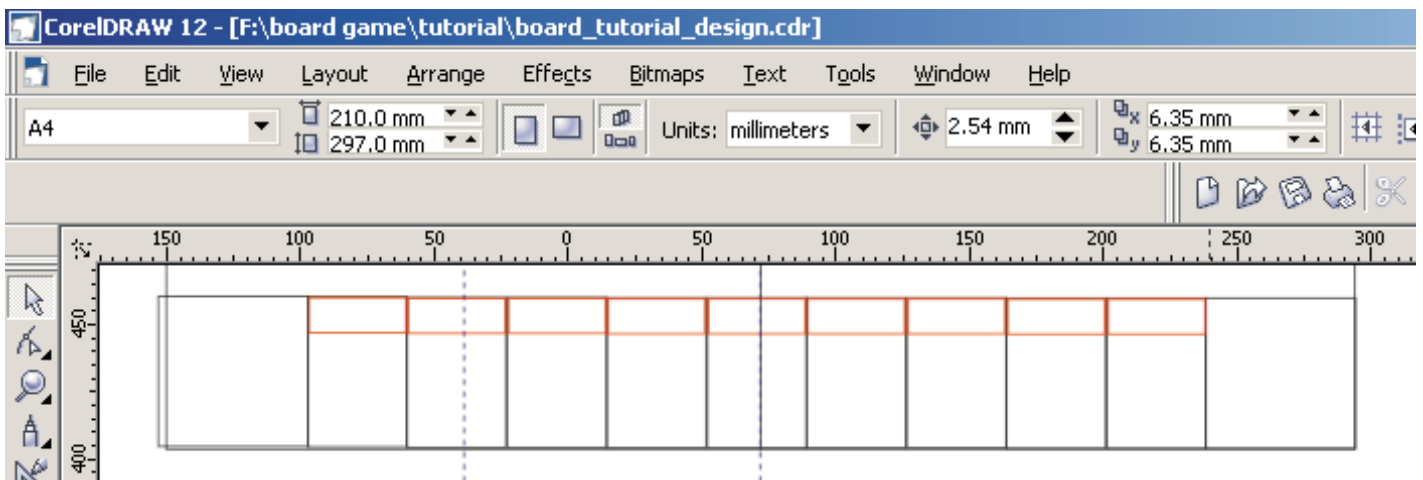

21) Now keep on copying and aligning the boxes until you have nine. Then copy and paste the end square at the other end.

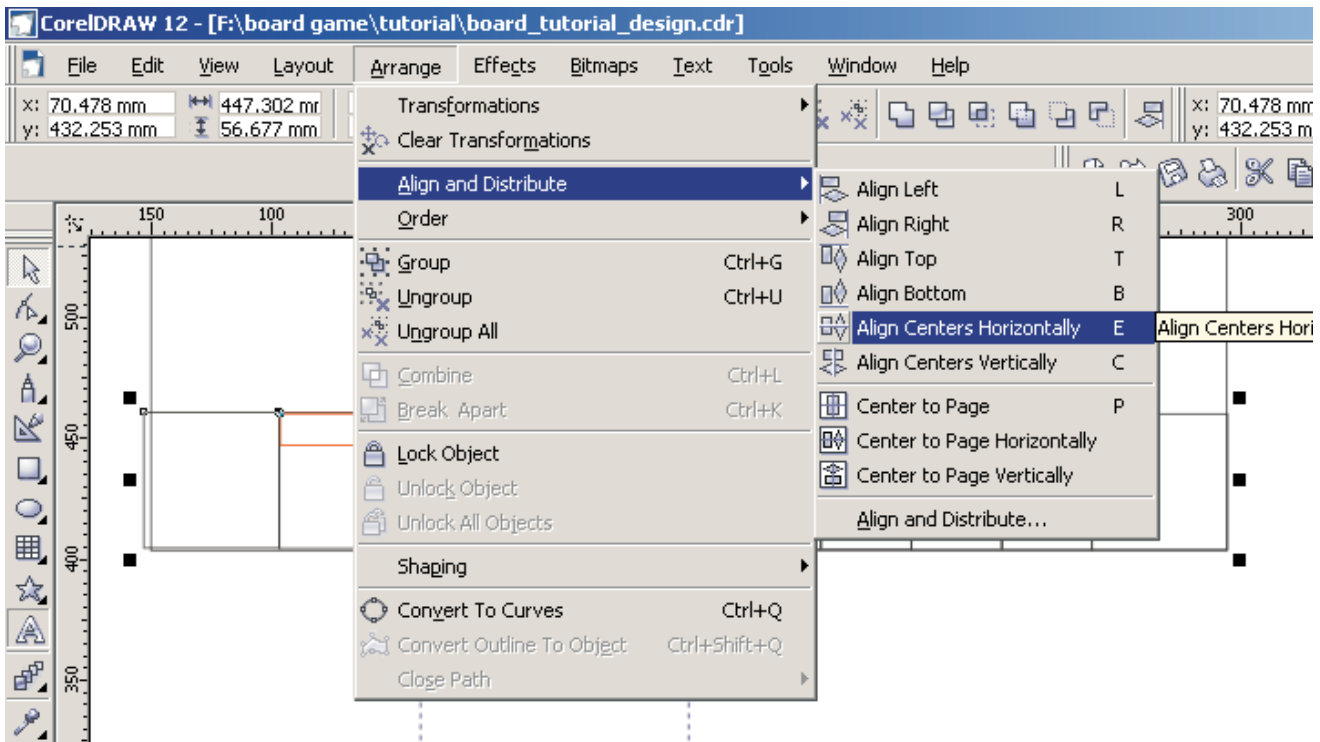

22) Now draw a rectangle around the selection and select > arrange > align > align centres horizontally.

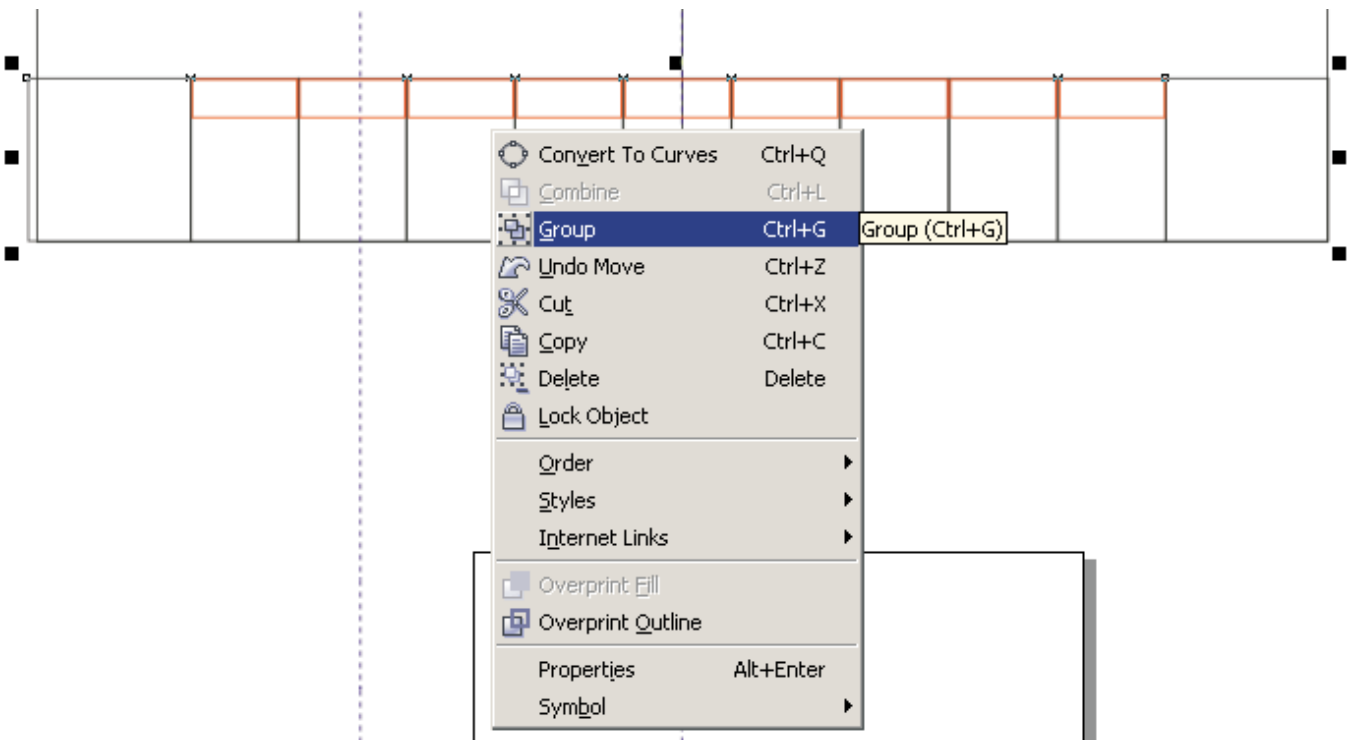

23) Now zoom in and make sure all your shapes are exactly the same line width apart. If not move them so they look the same. Now draw a rectangle around the selection and right click on it and press group. Now set the width of the shape to be 444mm this will ensure it fits your board.

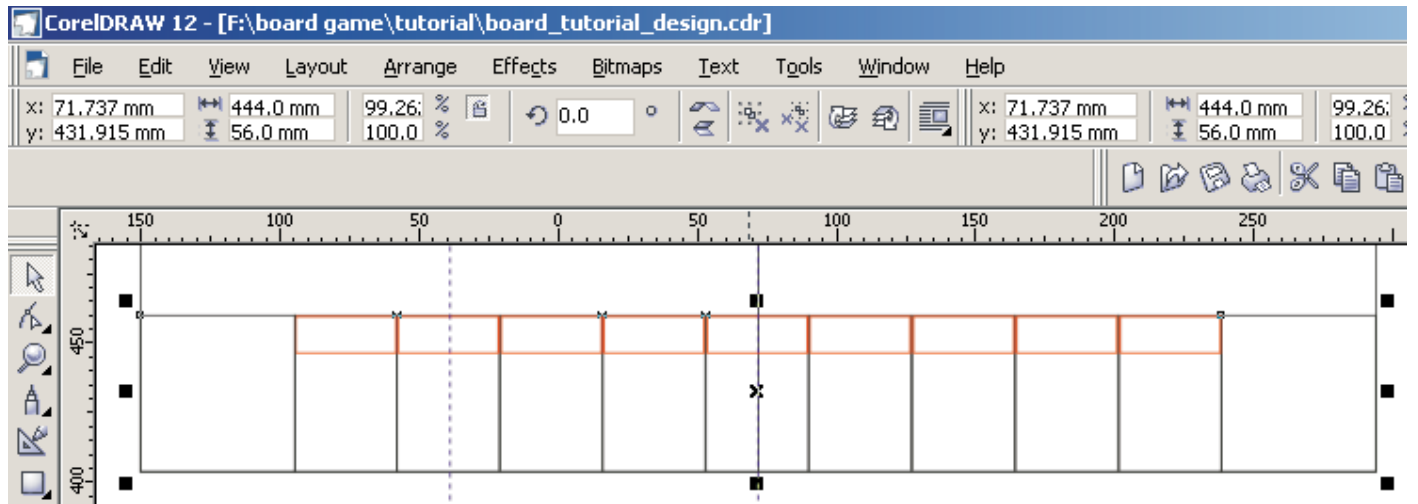

24) Now move your selection to the end to ensure it lines up with the outside square. Zoom in to ensure this is lines up.

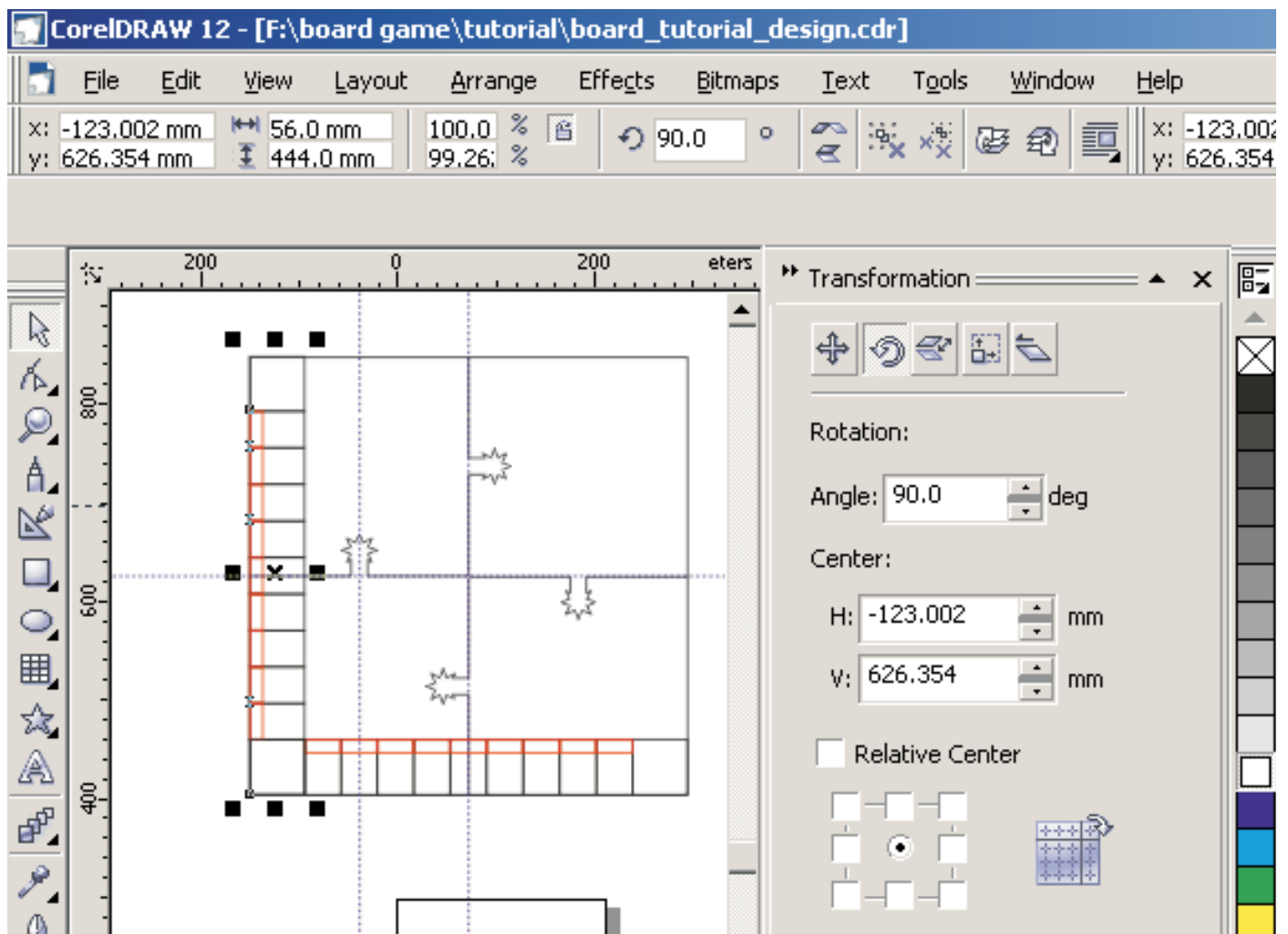

25) Now copy the selection and rotate it 90 degrees. Now zoom in and align the selection up with the other square in the corner. Next copy it again and rotate it again until you fill the whole board. Again zoom in and make sure you have aligned all the shapes.

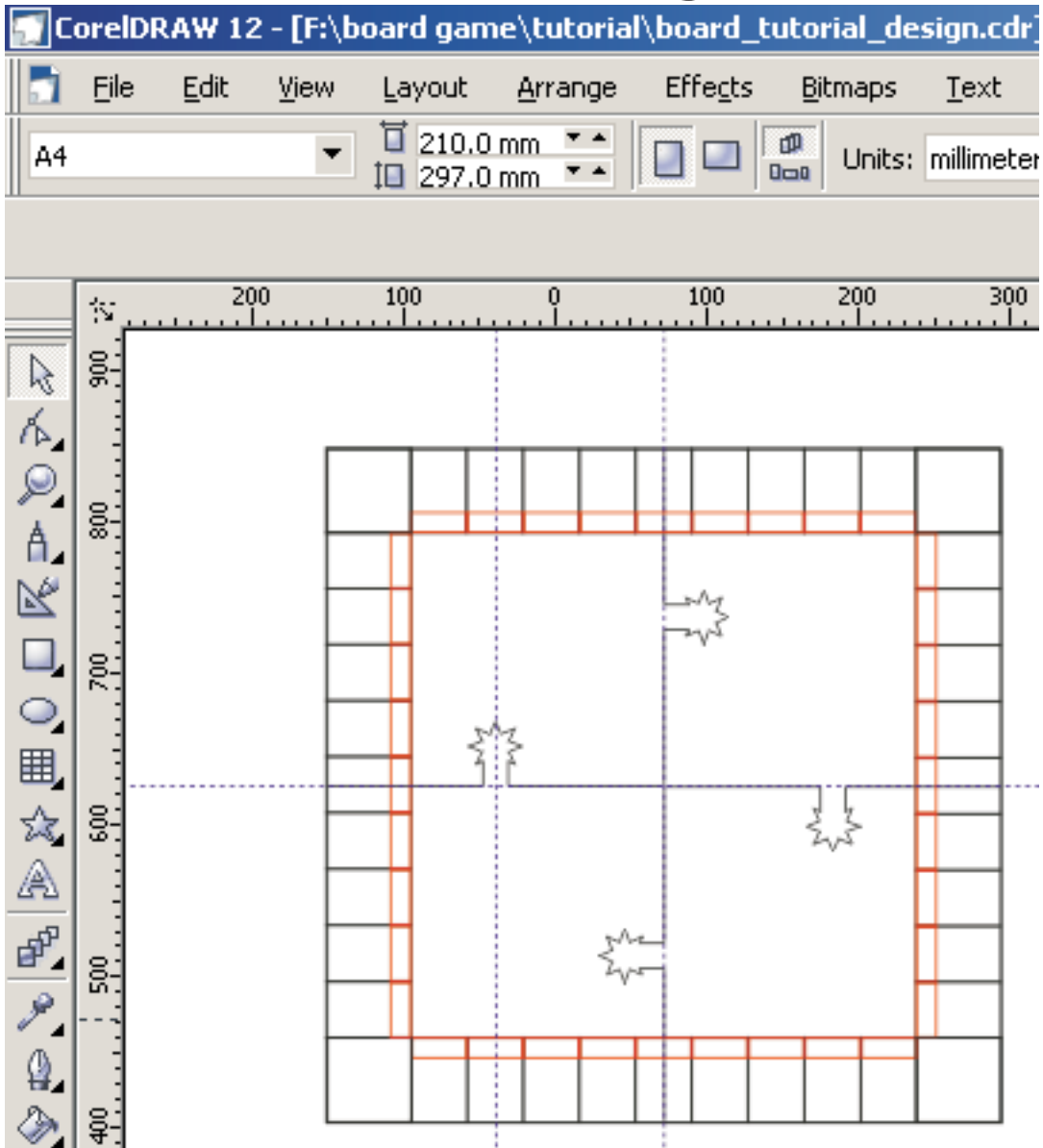

26) Now your shape should look like this above. Zoom in and ensure all the lines line up correctly. Now right click on each grouped row of squares and select 'ungroup' from the menu.

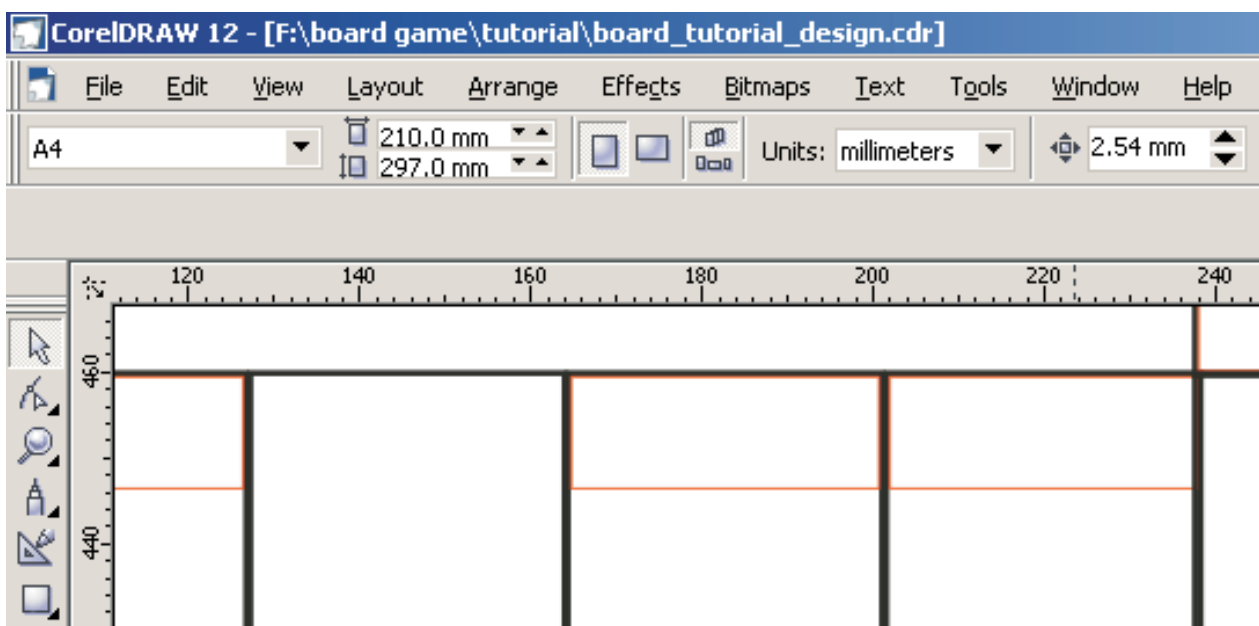

26) Now look at a monopoly board that your teacher has and ungroup then delete the red panels that do not appear on the monopoly board game. Do this for the whole board.

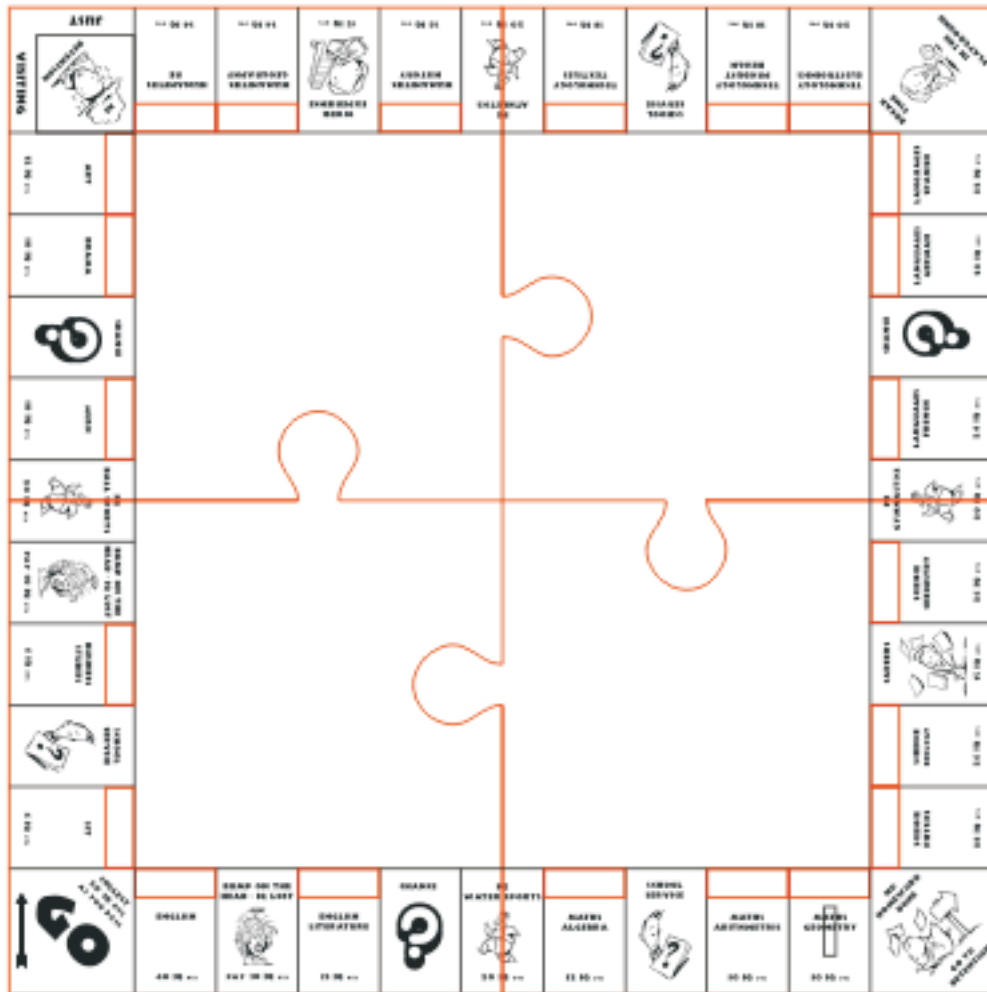

28) Now add your graphic or imported clipart from power point. Ask your teacher for the power point clipart tutorial sheets. Make sure everything that is to be engraved is black and everything that will be cut out is in red as a hairline!